

Data Sheet



Article number: 604133036085

Description: Taper bored timing belt pulley
HTD 36 14M 85 TL 3020

Measures

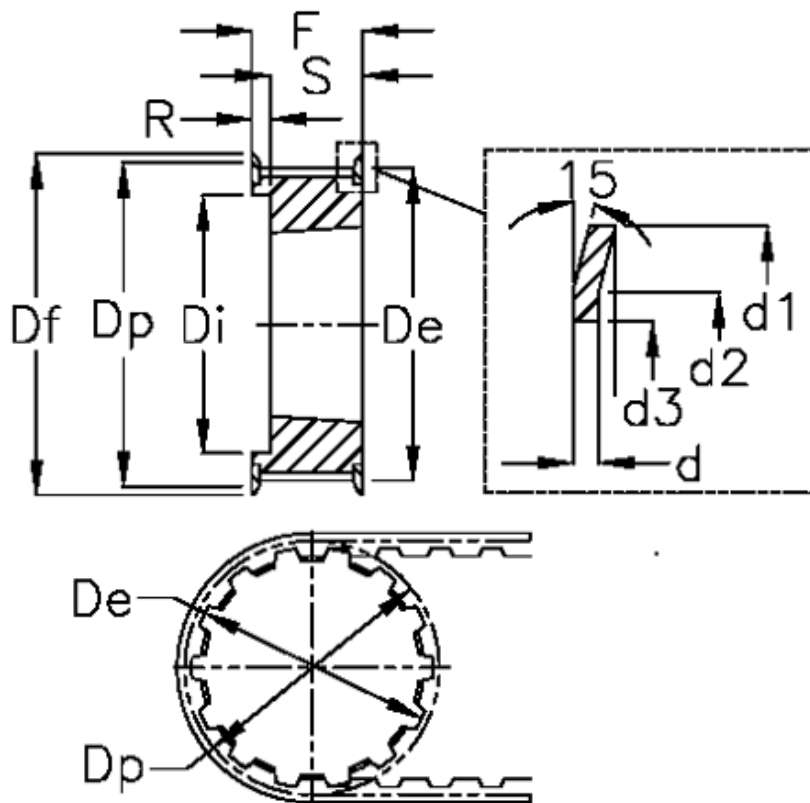

$d = 2.5$	F = 102	Weight = 5.8
$d1 = 168$	Flange type = F52	Width = 85
$d2 = 161$	For bushing = 3020	
$d3 = 148$	Max bore = 75	
$De = 157.68$	r = 25.5	
$Df = 168$	S = 51	
$Di = 120$	Tooth number = 36	
$Dp = 160.43$	Type = 14M	